

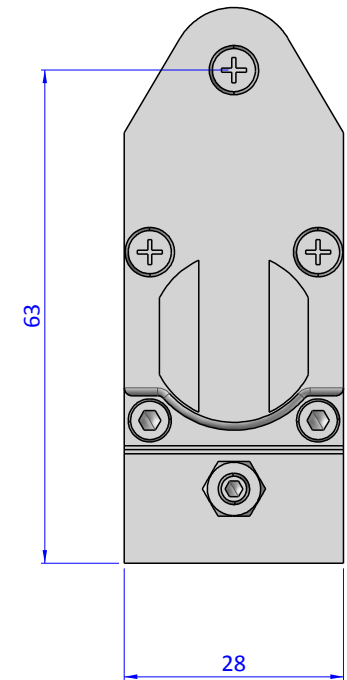

THE PROPERTY OF THE DRAWING IS ESTABLISHED BY LAW. IT IS FORBIDDEN TO PRODUCE OR SHOW IT TO THIRD PARTY, WITHOUT A WRITTEN AGREEMENT.

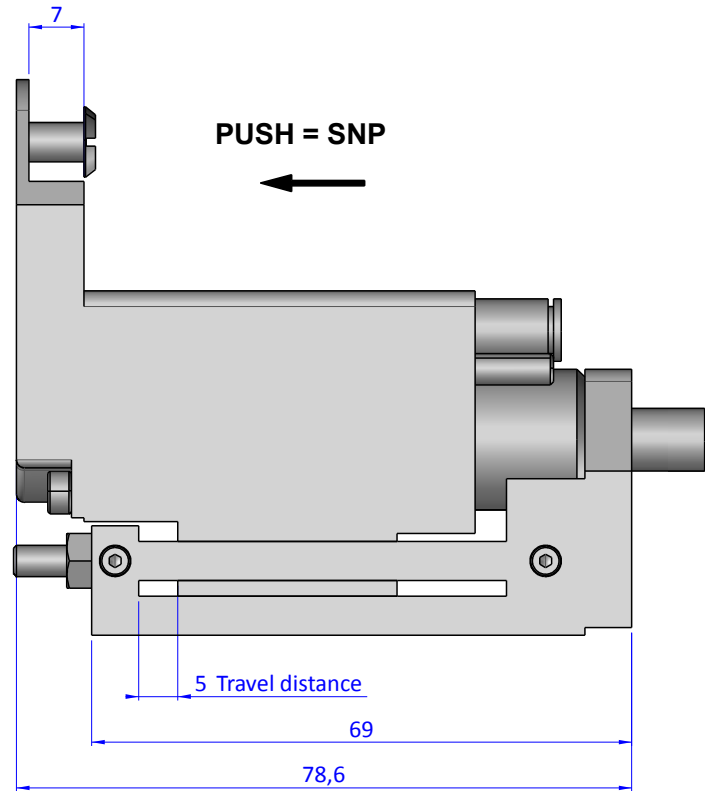
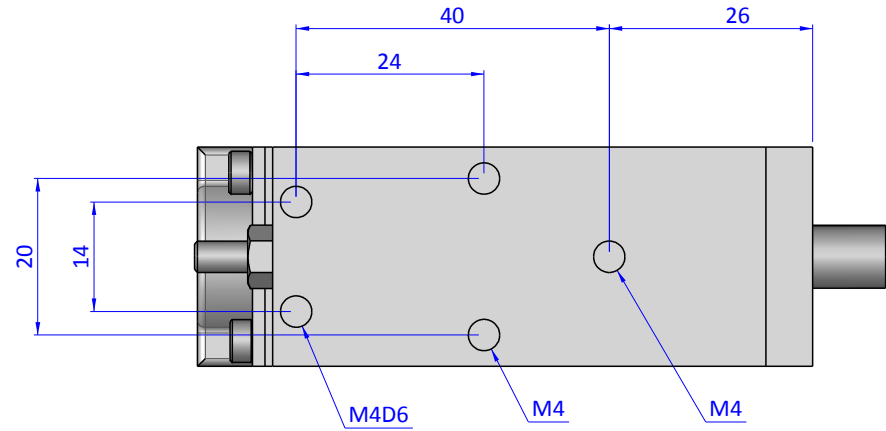
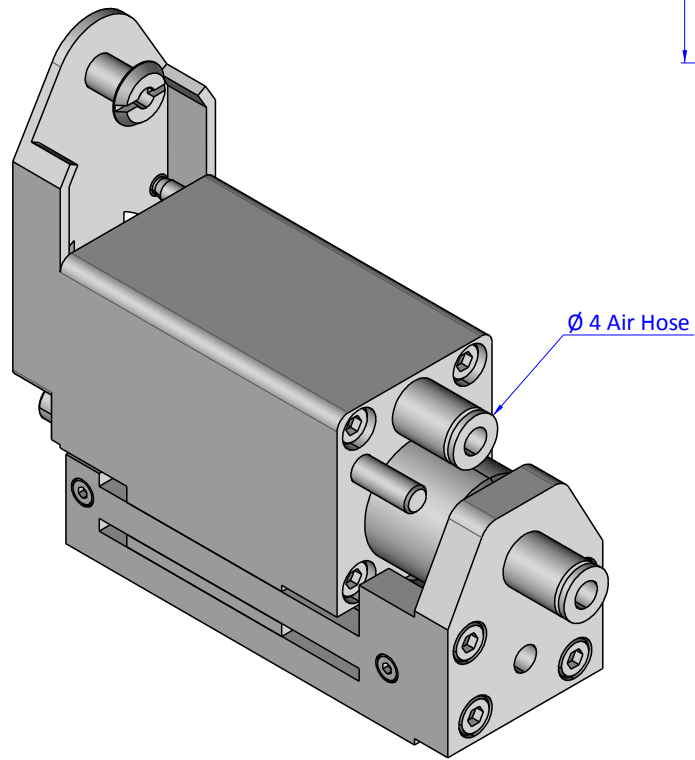

Format A3

UNI 936-76

 FPS SERVICES AUTOMATION		DESIGNED FROM		REVIEW
		FPS Automation		A
GENERAL TOLERANCE		DATE	WEIGHT	
UNI - ISO 2768		20/09/2018	0,220Kg	
CLASSE f	DESCRIPTION	CODE		
	CA.SNP5	CA.SNP5		